

OUTLINE DIMENSIONS
3-PHASE INDUCTION MOTOR

MOTOR TYPE:

FRAME NO. 365T

Totally Enclosed Fan-Cooled Type.Squirrel-cage Rotor.

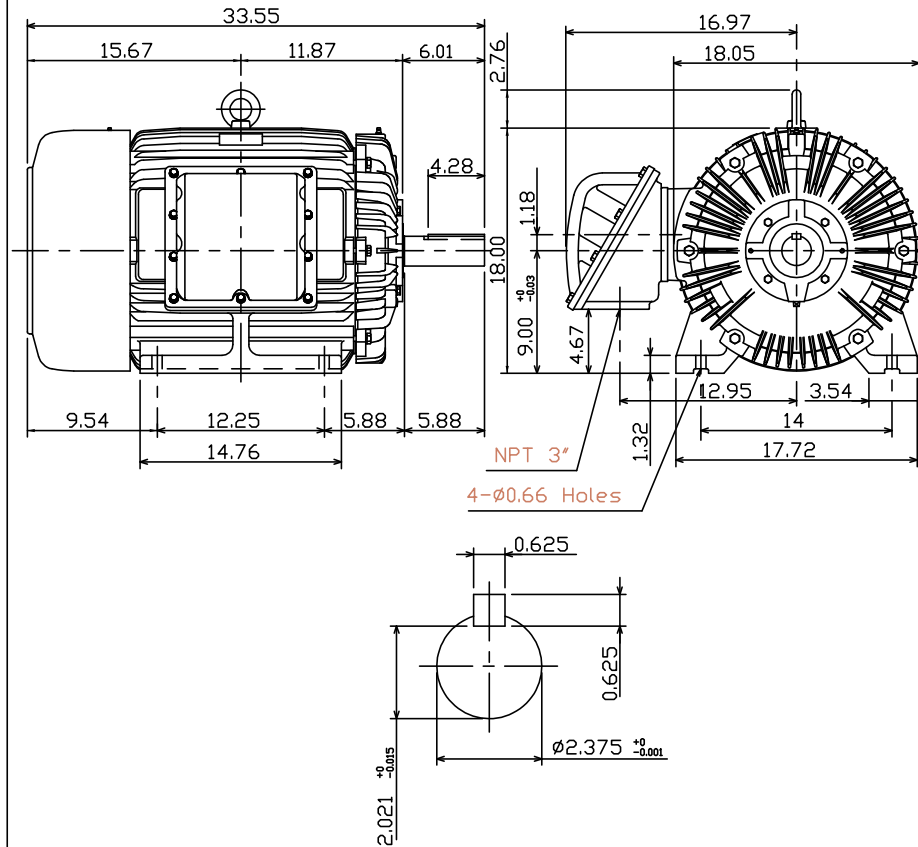

Note:
1. Explosion-proof:
Class I Group D and
Class II Group E,F,G.

**BROOK
CROMPTON**

DWG NO.