

OUTLINE DIMENSIONS
3-PHASE INDUCTION MOTOR

MOTOR TYPE:

FRAME NO. 184T

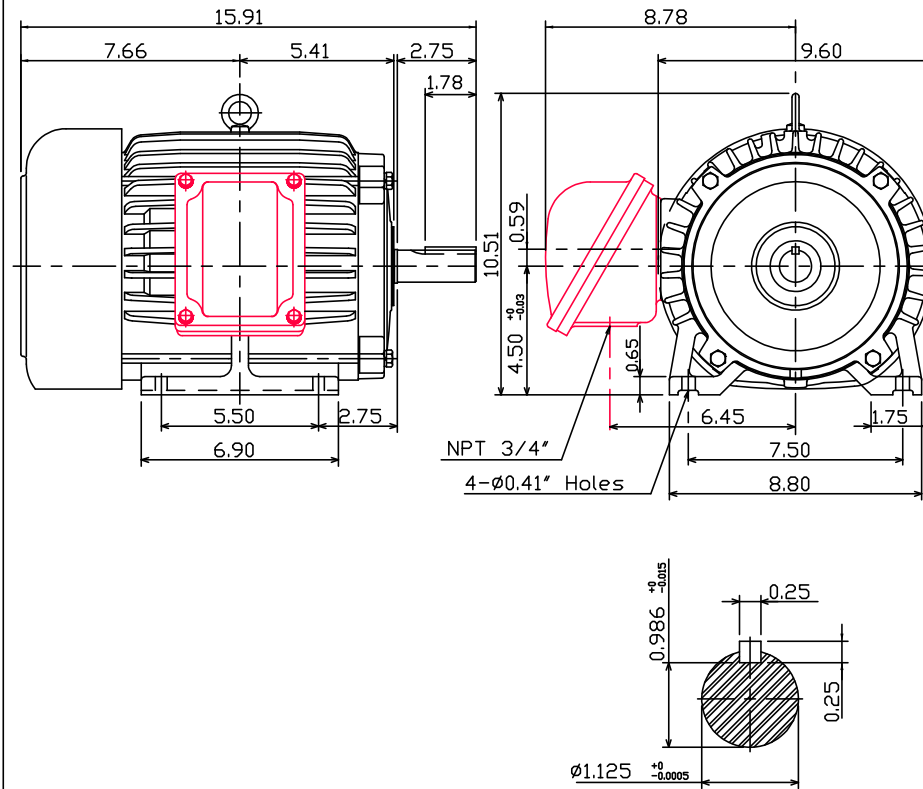

Note:

1. Explosion-proof:
Class I Group C,D and
Class II Group E,F,G.

**BROOK
CROMPTON**

DWG NO.