

OUTLINE DIMENSIONS

MOTOR TYPE:

3-PHASE INDUCTION MOTOR

FRAME NO. 365TC

Totally Enclosed Fan-Cooled Type, Squirrel-cage Rotor.

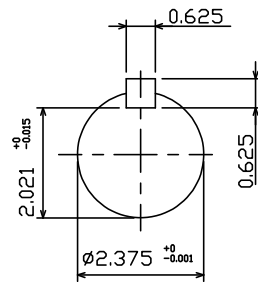
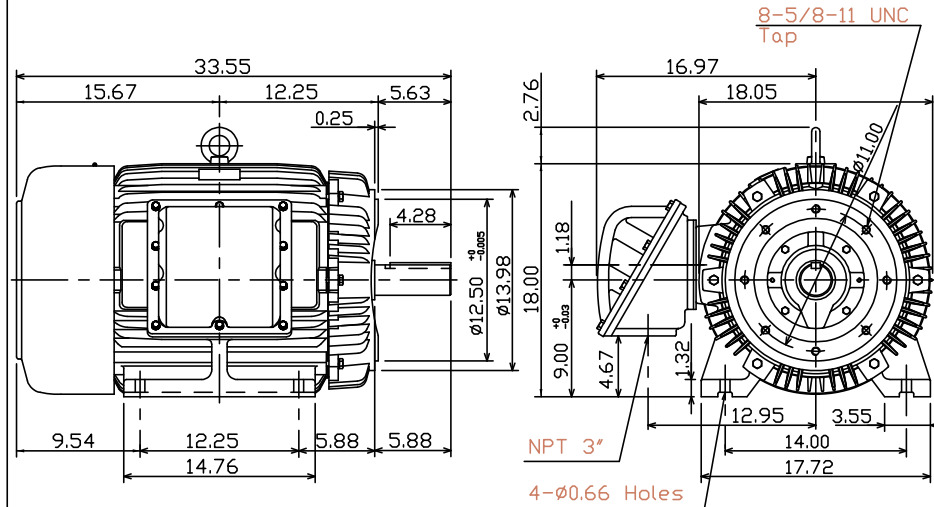

Note:

1. Explosion proof:
Class I Group D and
Class II Group E,F,G.

**BROOK
CROMPTON**

DWG NO.