

OUTLINE DIMENSIONS
3-PHASE INDUCTION MOTOR

MOTOR TYPE:
FRAME NO. 143TC

Totally Enclosed Fan-Cooled Type.Squirrel-Cage Rotor.

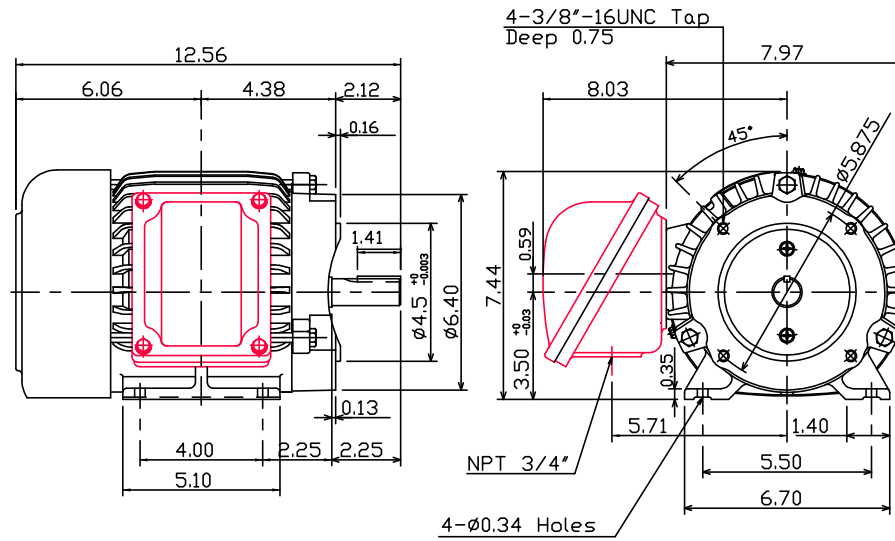

Note:
1. Explosion proof:
Class I Group C,D and
Class II Groups E,F,G.

**BROOK
CROMPTON**

DWG NO.